

OLYMPUS[®]

RESEARCH SYSTEM MICROSCOPE

AX70

PROVIS

UIS
UNIVERSAL
INFINITY SYSTEM

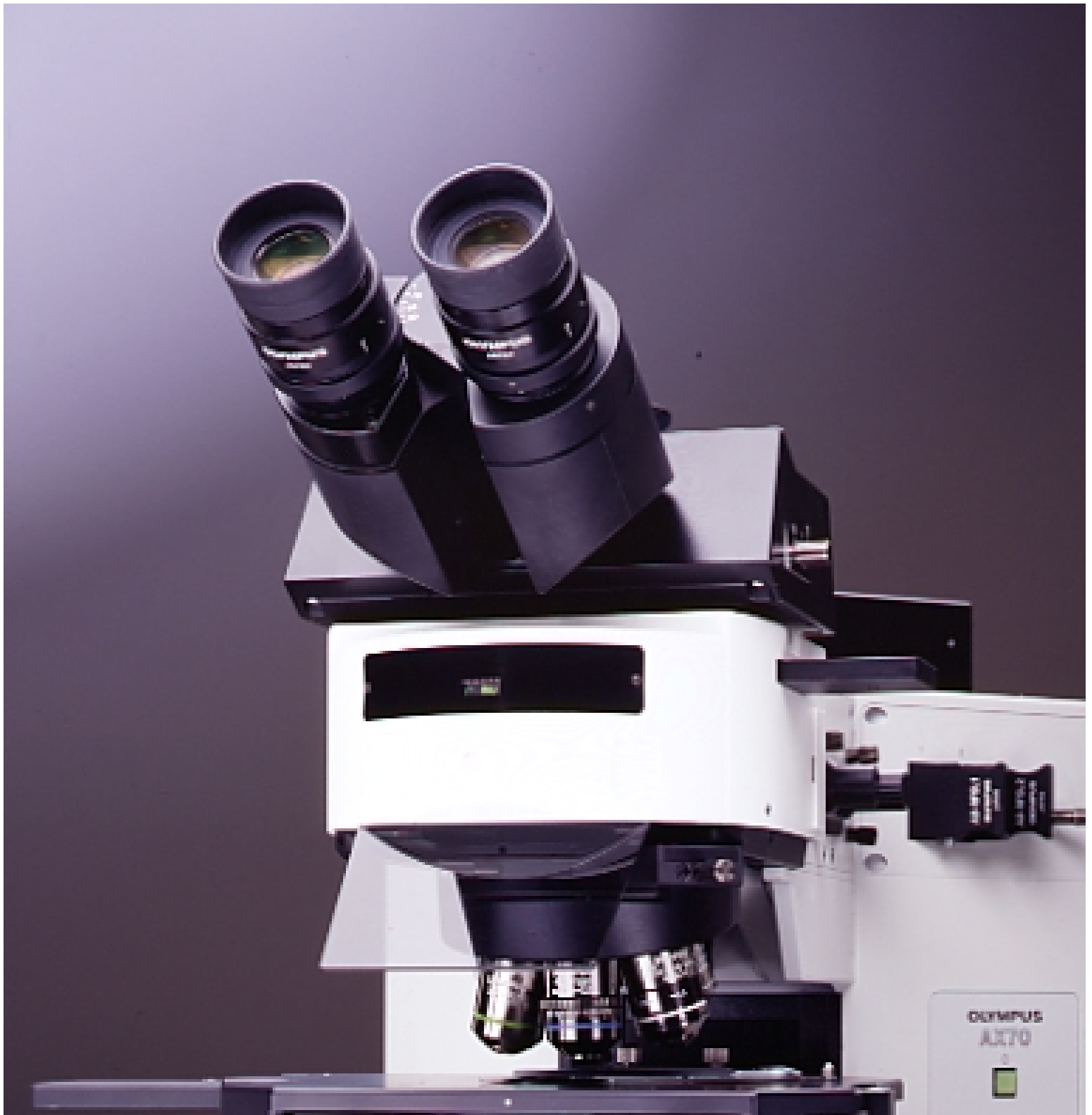

PRO

Essential
research equipment.

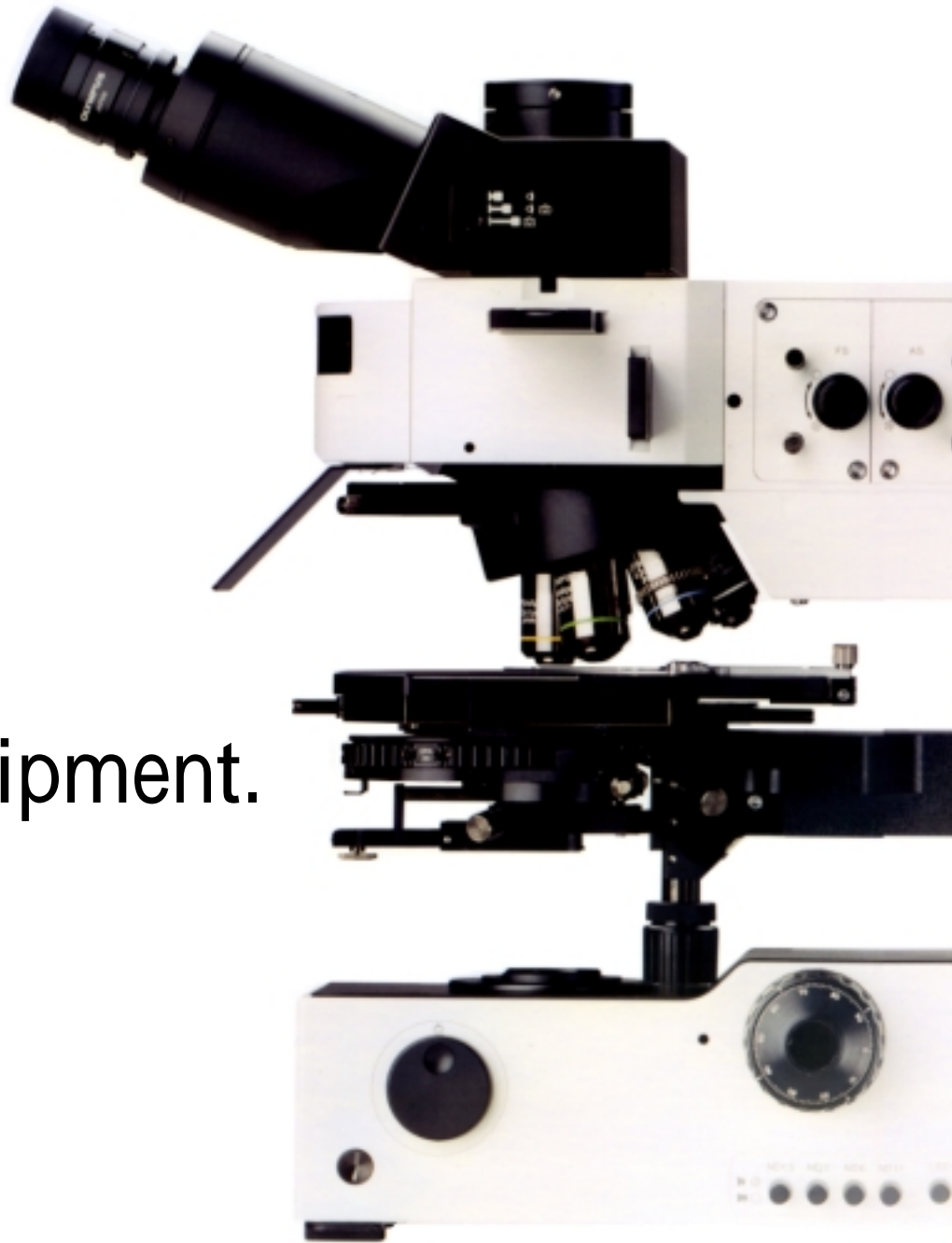

The reference
for future mi

PROVIS

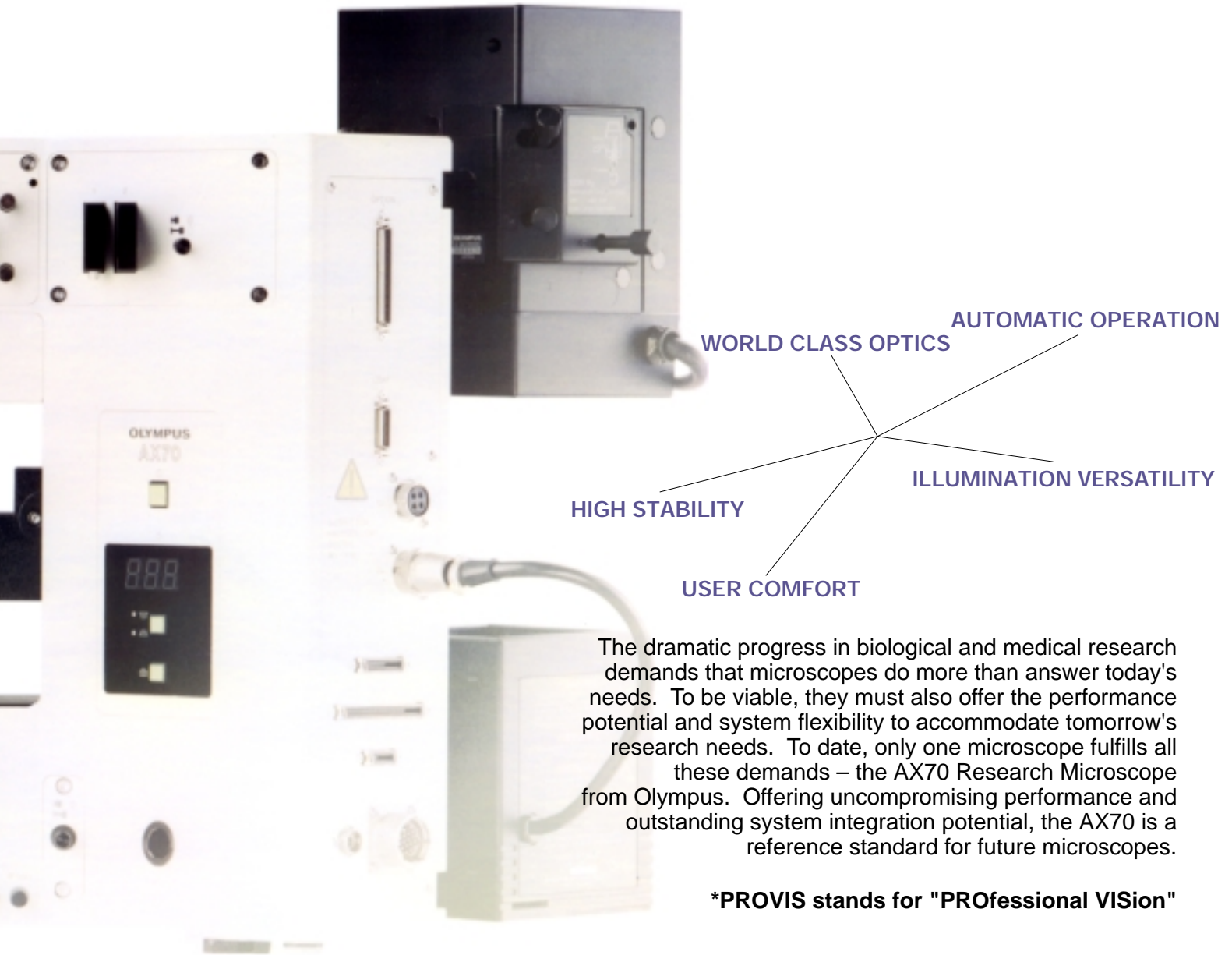

The dramatic progress in biological and medical research demands that microscopes do more than answer today's needs. To be viable, they must also offer the performance potential and system flexibility to accommodate tomorrow's research needs. To date, only one microscope fulfills all these demands – the AX70 Research Microscope from Olympus. Offering uncompromising performance and outstanding system integration potential, the AX70 is a reference standard for future microscopes.

***PROVIS stands for "PROfessional VISion"**

Reference standard microscopes.

AX70 and it's Universal Photo System – the ultimate combination for fully automatic photomicrography.

The AX70 and its automatic photomicrography system represent the ideal combination for scientific applications. Using the AX70 together with the U-PHOTO Universal Photo System provides a very advanced level of microscope performance and sophisticated photomicrography capabilities. Combining the mainframe and its corresponding auto focus function with the U-AFPHOTO and motorized units integrates innovative technology with a system that fully supports automated photomicrography. This combination offers fast auto focus in brightfield, darkfield, fluorescence*, and Nomarski Differential Interference Contrast*, and provides automatic light intensity adjustment for the objective in use as well as automatic observation light path selection. Flexible moving spot measurement ensures optimum exposure regardless of specimen distribution. A built-in Super FL Auto mode offers fully automatic exposure control for fluorescence photomicrography. And easy, flexible framing is assured via the zoom magnification system. By centralizing operation with a multi-control box, the entire procedure from observation through photomicrography can be effectively automated. The U-PHOTO 20/80 is also available from Olympus for simultaneous eyepiece and video camera observation.

*The Auto focus can be activated by inserting an optional memory card in fluorescence and Nomarski DIC microscopy.



AX70 + Universal Photo System

Effective solutions to research demands from a flexible system geared to fulfill present and future requirements.



The AX70 starts by offering all the advantages of the proprietary UIS optical system to provide the best image quality possible – and adds universal adaptability for rapid changeovers between various microscopic techniques. The specially designed Y-shape frame assures superb operator comfort. A choice of illuminator systems suits a range of different microscopic methods. And the system's substantial frame accepts heavy attachments for image processing and photometry applications. These and many other advanced features boost the performance of the AX70 and ensure flexible system upgradability. Olympus further maximizes system versatility with various accessories including the AX-REXBA to optimally balance fluorescence for double-stained fluorescing specimens. The broad range of accessories available ensures that Olympus answers every user need. Thanks to these and other significant advantages, the PROVIS AX70 system accommodates increasingly complex and multi-faceted research and experimental requirements.

AX70



The Olympus UIS optics –
The new standard of excellence.



Aberration-free image even with added attachments.

Innovative UIS infinity-corrected optics, such as objectives, telan lenses, eyepieces and other lens units completely eliminate optical aberrations. In this system, light travels as parallel rays from the objective through the body tube. These rays are focused by the telan lens to form an aberration-free intermediate image. This principle allows attachments to be added between the objective and the built-in telan lens without any magnification changes or image quality deterioration.

Simple modification of microscopic systems.

The major drawback of conventional infinity-corrected optical systems is field flatness degradation and coma aberration. Such problems occur as the distance between the objective and telan lens is lengthened. Olympus solved this problem by developing new eyepieces to make it possible to add two intermediate attachments and assure superb field flatness. Now it is simple to integrate the researcher's own units into the microscopic system without additional lenses.

F.N. 26.5 for any microscopic technique.

Super widefield observation tubes enable the AX70 to have an extended field of view (F.N. 26.5) for brightfield, fluorescence, Nomarski DIC, phase-contrast and polarized light observations.

Ideal resolution and contrast

In the AX70's innovative UIS infinity-corrected optical system, light travels as parallel rays from the objective through the body tube. These rays are focused by the telan lens to form a completely aberration-free intermediate image. This principle allows various attachments to be added between the objective and the built-in telan lens without any magnification changes or image deterioration. The result is optimum

An impressive line of high-performance UIS objectives

PLAPO Series

Designed for unsurpassed resolution and contrast, these new Plan Apochromat objectives keep chromatic aberration down to an absolute minimum. Precision manufacturing allows the PLAPO Series to deliver maximum optical performance.

UPLAPO Series

The UPLAPO Series of Universal Plan Apochromat objectives features an unsurpassed high numerical aperture. In addition to brightfield observation, they offer perfect resolution and contrast during fluorescence, Nomarski DIC and darkfield observations.

UPLFL-PH Series

Universal phase-contrast objectives that provide the same critical optical performance as the UPLFL Series. A newly developed phase membrane allows a high-contrast image to be produced without using an interference filter.

UAPO/340 Series

Composed of strictly selected lenses, these universal objectives feature high transmission at 340nm. With a high numerical aperture, the UAPO/340 Series provides the maximum performance in fluorescence microscopy through near-ultraviolet excitation including Ca²⁺ photometry.

UPLFL Series

Cost-effective Universal Semi-Apochromat objectives deliver superb resolution and contrast with any microscopic technique such as brightfield, fluorescence, Nomarski DIC and darkfield. Olympus proprietary manufacturing technology makes possible high-precision objectives at affordable cost.

UPLAPO 60x WPSF Series

Outstanding optical performance combines with high numerical aperture and long working distance to make these Universal Apochromat water-immersion objectives ideal for 3D observations with a confocal laser scanning microscope. With improved near-ultraviolet transmission, these objectives can also be used for Ca²⁺ photometry.

UPLFL-P Series

Featuring outstanding optical performance like the UPLFL Series, innovative assembling technology has made the UPLFL-P Series completely strain-free. In combination with the Brace Koehler compensator, UPLFL-P objectives make high-sensitivity polarized light observation possible.

UAPO W Series

The UAPO W water immersion objectives feature a high numerical aperture. Thus, they enable the production of aberration-free images at every specimen level – from the surface down to deep sections – during examination of living cells or other specimens with a refractive index similar to water.

UPLAPO-PH and PLAPO60x PH Series

Objectives with the world's highest resolution and contrast for phase-contrast observation. Designed for phase-contrast microscopy, these objectives also perform faultlessly with brightfield and fluorescence observations.

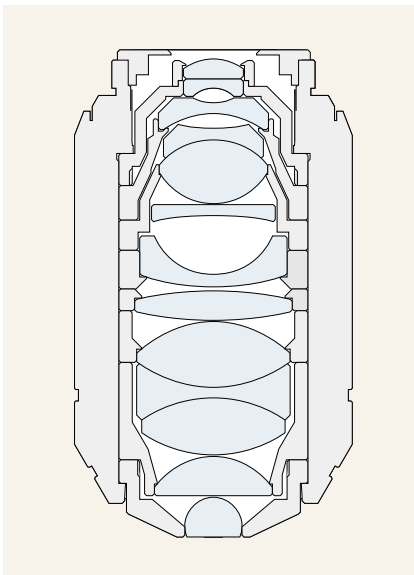

Maximum quality for
various microscopy applications.

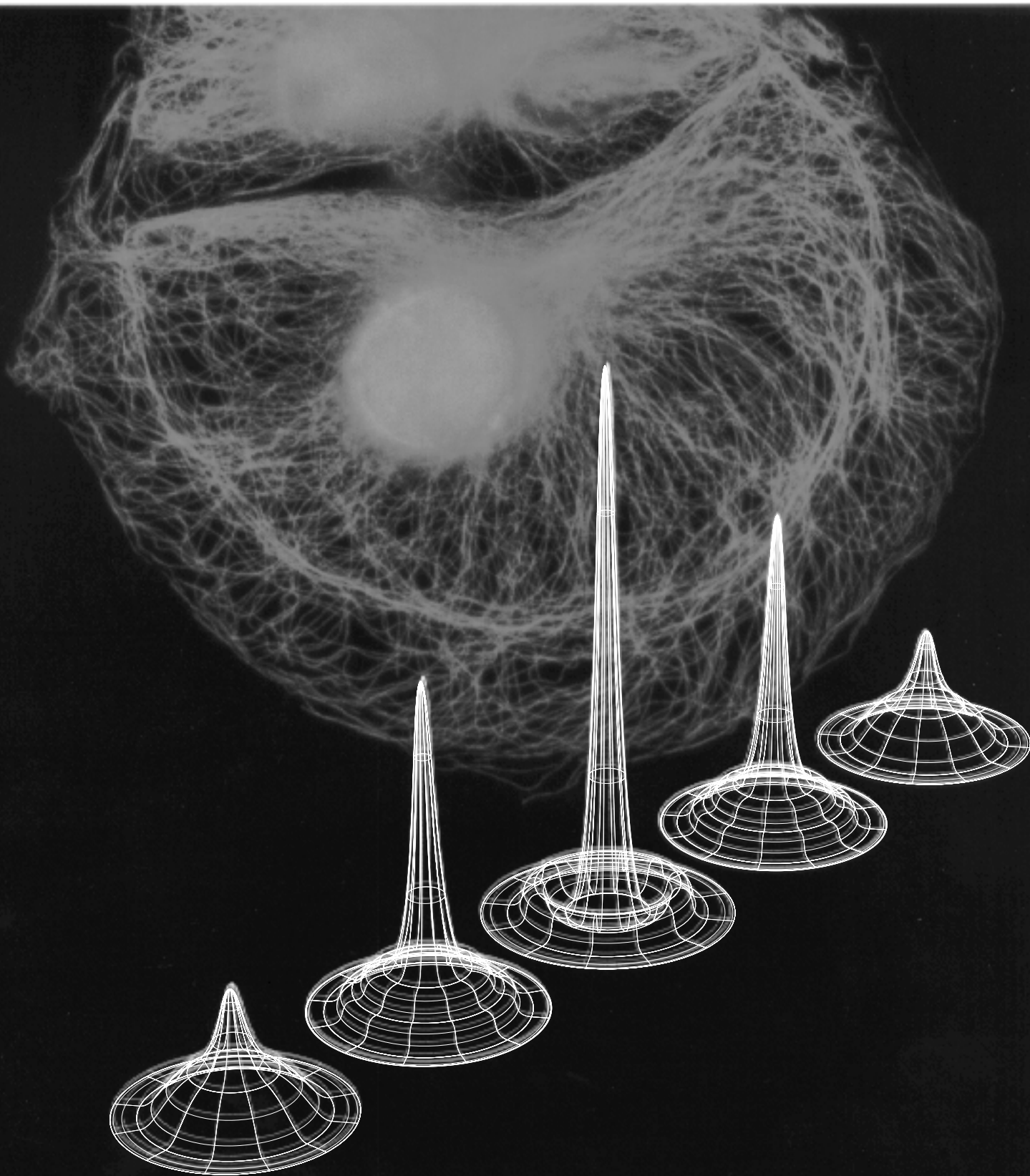

Bright, high-quality fluorescence images.

The AX optical system attains the very best brightness and assures crystal-clear fluorescence images by employing an improved numerical aperture and high transmission objectives and by incorporating a 100% optical path and high transmission optics. The ideal mirror unit for each application can be selected from a range of 18. The built-in illuminator accepts up to four mirror units, allowing the user to create the ideal combination for each purpose or for a combination of multiple observation methods. In addition, the motorized excitation light shutter also minimizes fluorescence fading.

Impeccable phase-contrast observation.

The AX Series features new phase-contrast objectives employing an optimally positioned innovative low-

reflection phase membrane.

Appropriate phase-contrast and transmission are ensured for a wide wavelength range for outstanding contrast and image quality.

Nomarski DIC with higher contrast and resolution.

Sophisticated manufacturing technology and new multi-coatings for the high-performance Universal Apochromat objectives guarantee superb optical performance for fluorescence and Nomarski DIC observations. Nomarski prisms specially developed for Video Enhanced Contrast and metallurgy are also available.

Design algorithms suited for polarized light observation.

The entire UIS optical system including high-precision, strain-free POL-objectives, condensers and observation tube prisms has been designed to minimize reflections from

lens surfaces and frame. Together with dedicated Olympus optical design algorithms, this ensures unmatched image contrast for polarized light observation. Used with the Brace Koehler compensators, these objectives allow high-sensitivity examination of biological samples.

Live cell imaging.

The special correction of the UPLAPO60x WPSF objective renders symmetrical image information from planes above and below the focal plane.

This imaging symmetry makes it the objective of choice of digital deconvolution applications. The water immersion correction of the objective eliminates spherical aberration when imaging live material, even when observing deep within a cell (up to 250µm). At the same time, the objective's high numerical aperture (N.A. 1.20) achieves spectacular resolution.

Defocus images of the point spread function

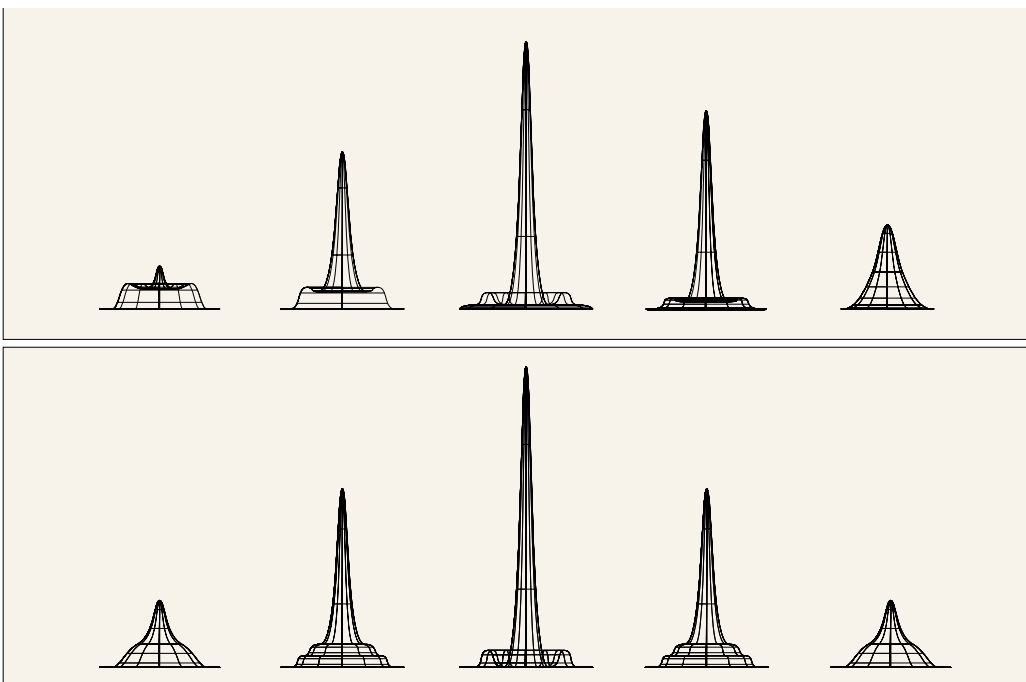

General objectives

Non symmetry of image information from the planes above and below the focus level as obtained with well corrected objectives.

PSF objectives

The special correction of the UPLAPO60x WPSF objective renders symmetrical image information from planes above and below the focal plane.

A range of illuminator systems for advanced research applications.

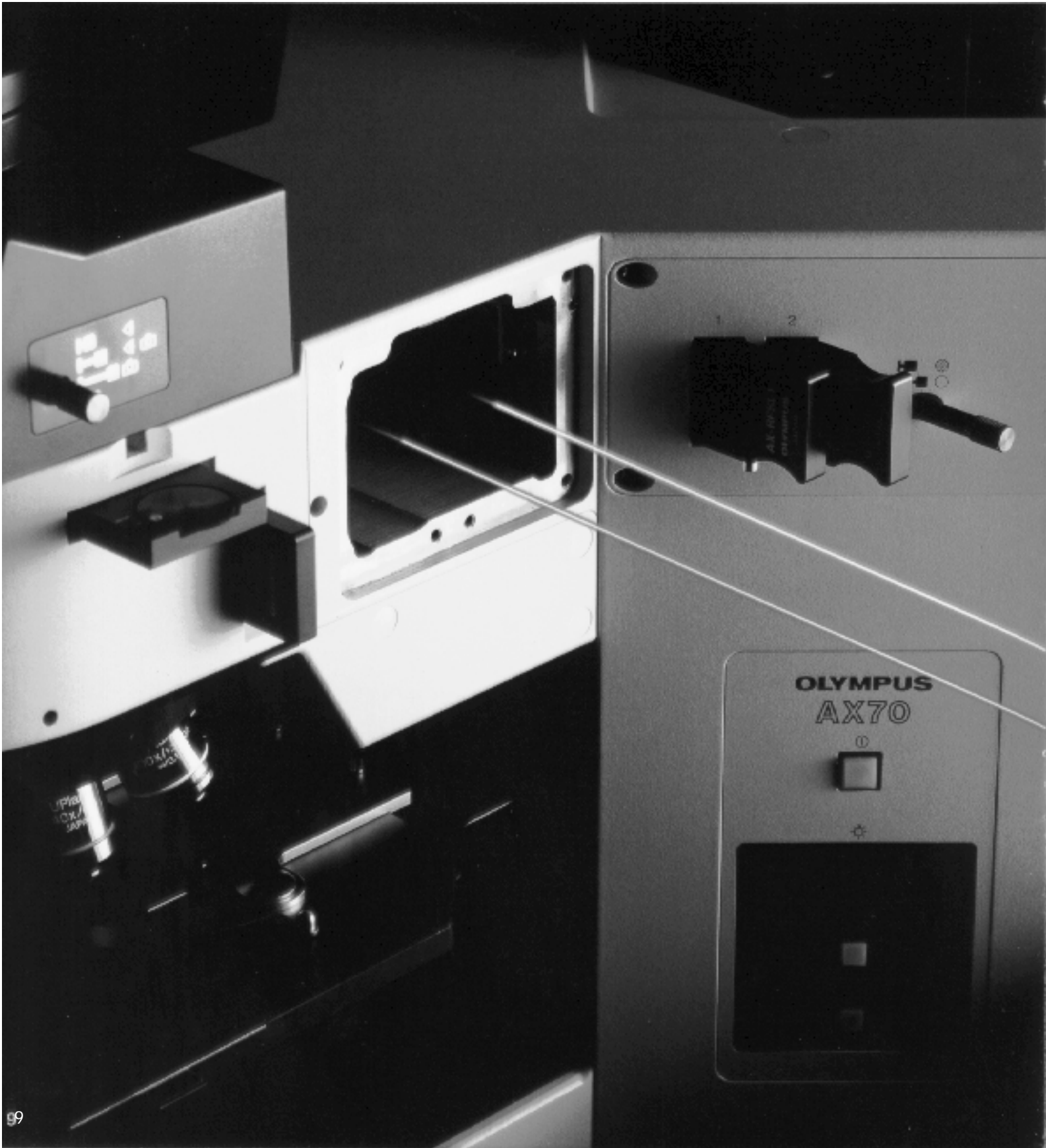



Photoactivation of caged fluorescein. Caged fluorescein labeled tubulin had been introduced in the cell; after exposure to UV light through a slit a photoactivated zone was generated.

Field stop and aperture stop units for easy attachment of laser and other special illuminators.

Removable field stop and aperture stop units facilitate simple attachment and detachment of laser and

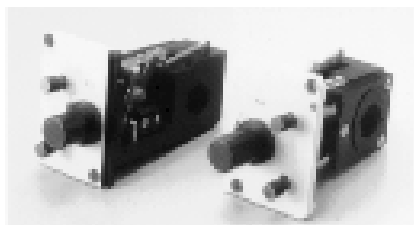

additional illuminators. This versatility permits application-specific incident light illumination. In particular, it enables laser illumination for laser manipulation and caged compound release photoactivation.

Twin-lamp housing configuration with a quick, one-touch illumination changeover.

Two lamp housings can be mounted simultaneously onto the AX70 to significantly expand the microscope's potential. Infrared (IR) excitation and

conventional ultraviolet (UV) excitation are both required when fluorescence microscopy moves toward multi-staining. However, this requires switching the light source from the conventional mercury burner to a halogen source. The twin-lamp housing configuration on the AX70 makes the switchover between the mercury burner and halogen source a simple operation.

Quick excitation light switchover – a convenient feature for various photometry and measurement applications.

Working in combination with the OSP100-DNA photometry system, the AX70 easily handles different measuring methods using several fluorescent indicators. These range from 1-wavelength excitation/1-wavelength photometry (1Ex1Em) to 2-wavelength excitation/2-wavelength photometry (2Ex2Em). Thus, the AX70/OSP100 combination can measure fluorescence intensities at a single wavelength with dual-wavelength excitation using the fura-2 or BCECF indicator. These advantages make it ideal for analyzing intracellular calcium ion concentrations and pH values.

Application example

PAF (Photoactivated Fluorescence)

The PAF technique irradiates caged compound with an ultraviolet ray, instantly transforming them to original active substances. The induced reaction is then measured and examined. PAF also allows control of intracellular reaction time and location.

Applications

- Examining muscle contraction due to increased intracellular Ca²⁺ concentrations.
- Study of cytoskeleton assemblies.
- Ion channel research.
- Study of receptor-bonding of neural transmitters and their functions.

AX70 – the obvious choice

The AX70 incorporates a vertical illuminator with sideways illumination capability.

The Y-shape also provides an uncluttered work surface for conveniently positioning an injector or other ancillary equipment near the stand. An upright microscope is required to observe internal structures of cells (with samples usually measuring 100 - 200µm thick).

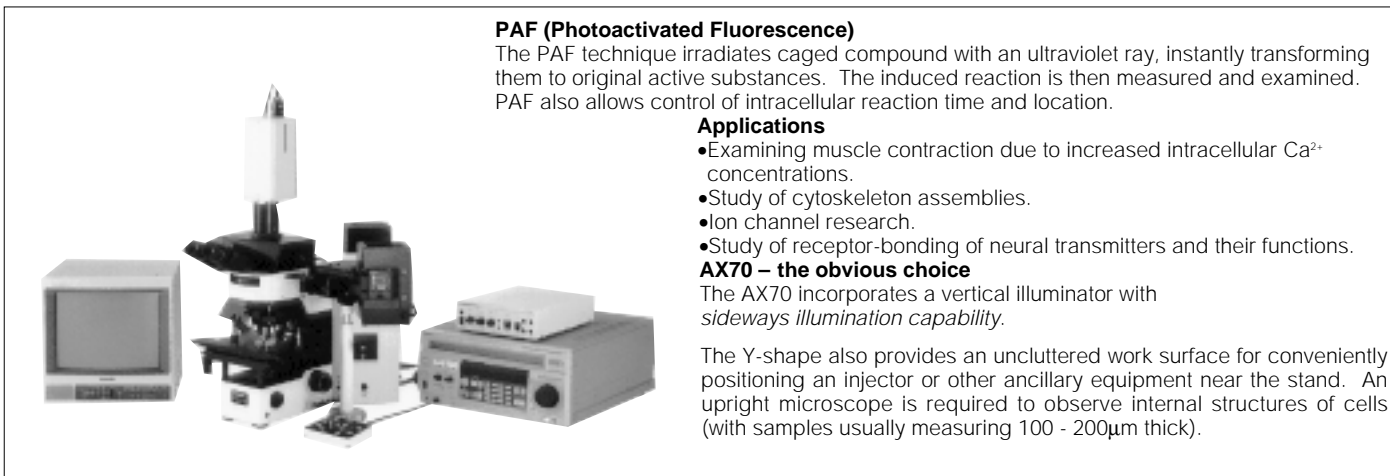

Structural integrity for vibration resistance, weighty accessories and thermal stability.

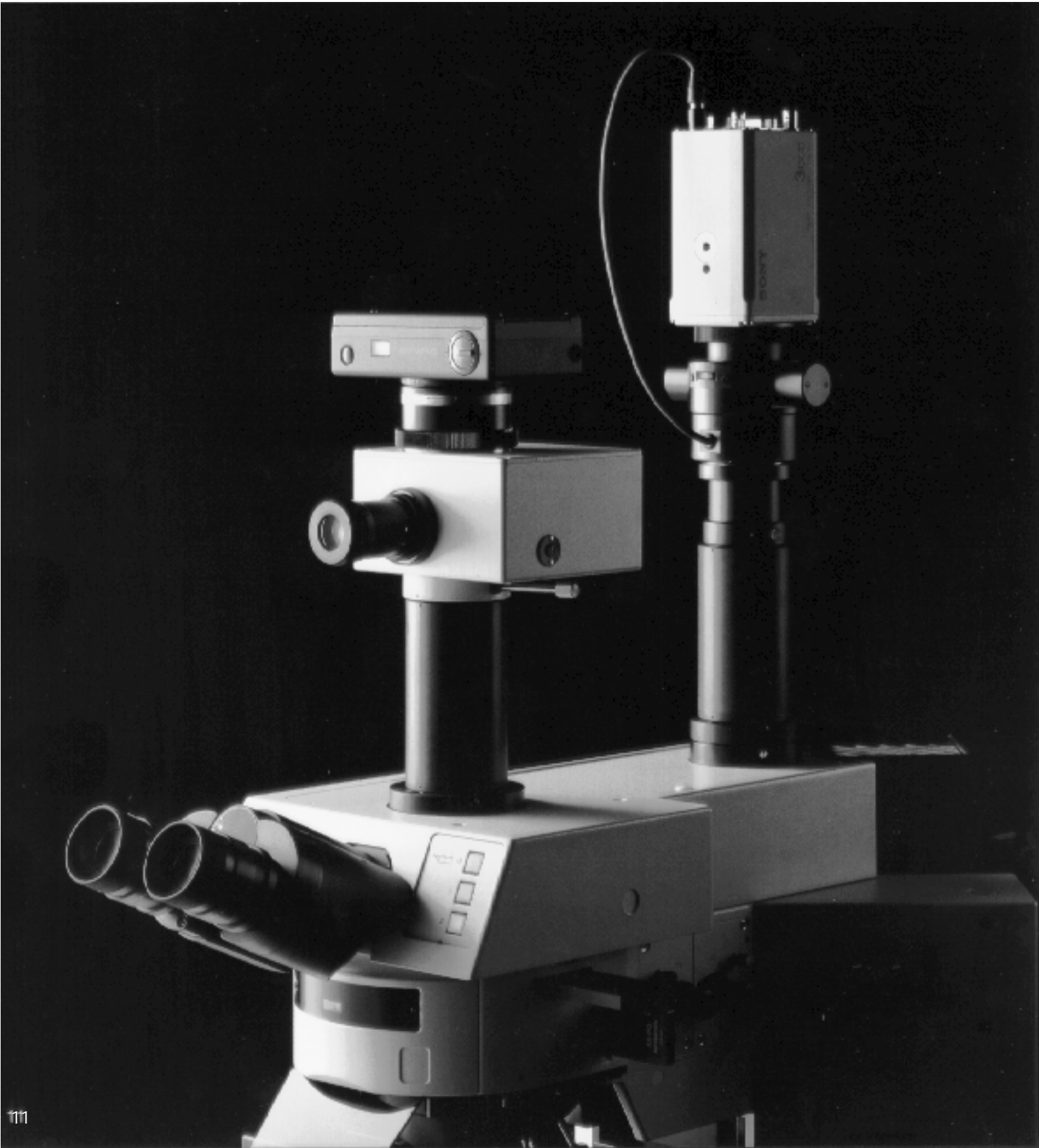

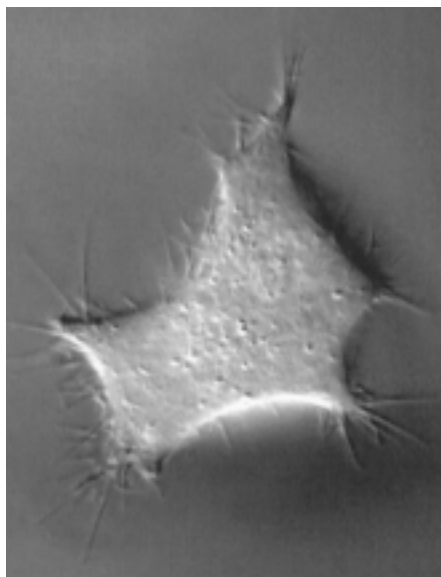
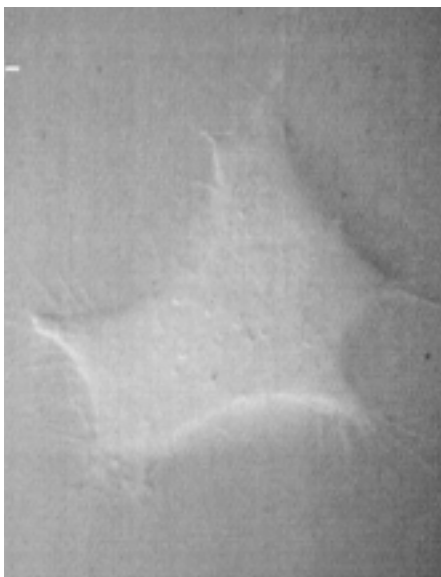

NG108
Left: prior to enhancement
Right: VEC+DIC

Frame stability – the basis of system flexibility.

Current biological research applications require more than a high-quality microscope. They demand a complete system configuration including image processor, photometry system and laser source. To enhance system flexibility, the frame must be strong enough to support the heaviest attachments. To achieve an exceptionally rigid frame for the AX70, Olympus used advanced computer simulation techniques in the design process.

Heat-resistant light source structure.

The power supply represents a source of heat for microscopes. To achieve the best long term thermal stability, the power supply was removed from the body of the microscope. The AX70 was also given a heat-insulating structure to reduce the temperature influence of the lamp housing on the frame. These measures effectively minimize heat-induced frame flexure on the AX70.

Vibration-resistant rigidity ensures the best results for electrophysiological experiments.

The AX70's tripod-like frame design offers a wider work surface and reduces installation space requirements. In addition, it provides rock-solid stability.

Application example



Video Enhanced Contrast

A low-contrast sample unidentifiable in ordinary microscopic observation can be recorded using a high-sensitivity camera, and contrast-enhancement by means of image processing. The result is unprecedented image contrast and sharpness. A Nomarski DIC attachment with a greater numerical aperture for higher resolution is optionally available for Video Enhanced Contrast (VEC) applications.

AX70 – the obvious choice

The AX70 accepts a high-sensitivity camera and high 2D resolution camera simultaneously using a multi-port head and offers superior stability for mounting a video camera. VEC objectives and Nomarski DIC prisms are also provided to deliver brightly illuminated, higher-contrast images.

Maximum operator
comfort at all times.

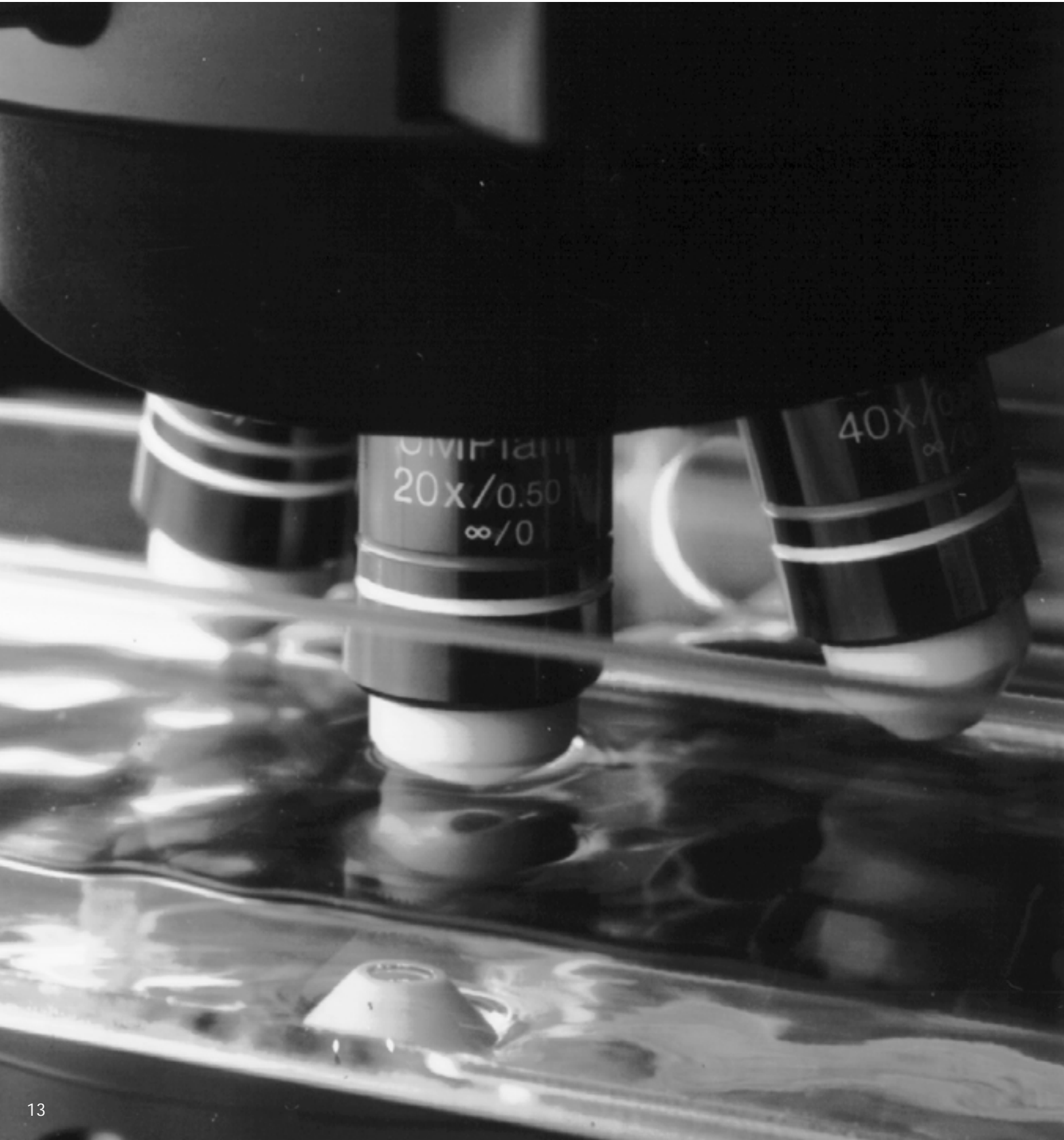

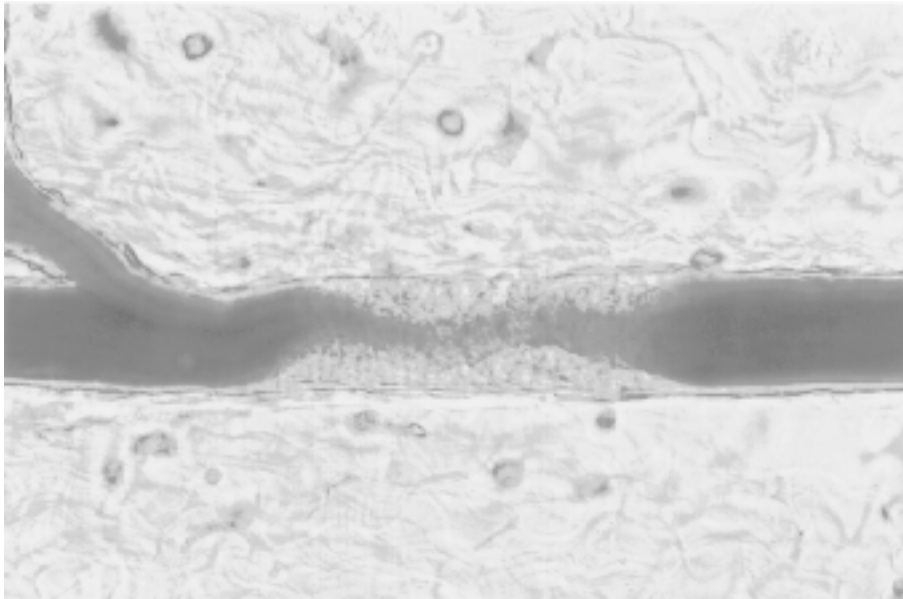

*The thrombus model in microcirculation of the rat mesentery/
LCPL 20x, Photo magnification 5x, brightfield*



An extra-wide stage – ideal for experiments and observation of small animals.

An extra-large 6" stage offers the ideal design for examining mice and other large specimens. The AX70 also has enough space between the stage surface and arm to easily accommodate large and thick specimens.

Improved operational ease for enhanced manipulation.

The revolutionary Y-shape of the AX70 frame offers unique user benefits. It

not only allows the operator's forearms to be supported by the worktable or bench surface, but also provides more working space. As a result, micromanipulators can be conveniently mounted. A multi-control box can also be mounted for easy system upgrades along with other peripheral equipment. The unique design allows arms and wrists to remain on the work surface while manipulating controls. Thus, efficient observation with less fatigue, even over prolonged periods, is possible.

Application example



Intravital Microscopy
When small laboratory animals such as mice etc. need to be microscopically studied, several prerequisites must be met. Next to suitable optics capable of saline immersion, a large work surface is needed to support the specimen as well as tools, perfusion equipment, etc.

Applications
Study of capillaries/microcirculation.

AX70 – the obvious choice.
The AX70 is ideal for mounting a large 6" stage, suitable for support of large specimens.

Automation facilitates research microscopy.



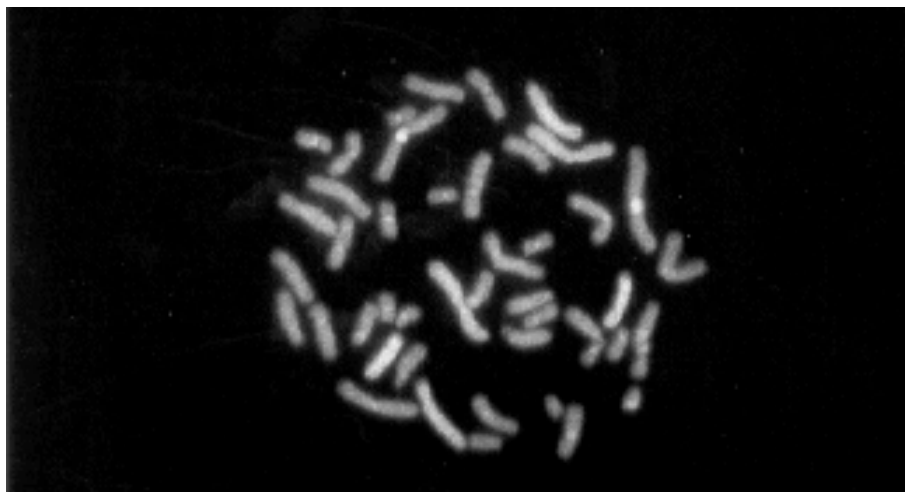

Chromosome - 1, 4 and 9 in human metaphase Chromosomes/
Spectrum Orange+FITC+DAPI/
UPLAPO 100x

different microscopic methods. The AX70 also includes a motorized filter changer and motorized revolving nosepiece to speed selection of excitation wavelength. In addition, the AX70 allows the operator to affect setting changes. This is achieved through the motorized field stop and aperture stop units, and the motorized filter changeover, which can be used to perform various microscopic illumination techniques automatically. The use of a multi-control box may automate many functions including photomicrography.

A computer-based control system.

For more advanced features, the multi-control box can be linked to an external computer via an interface. A computer control system can therefore be configured for other ancillary equipment connected for use in FISH, patch clamping and other biological research applications. Remote controlled photomicrography operation is also possible.

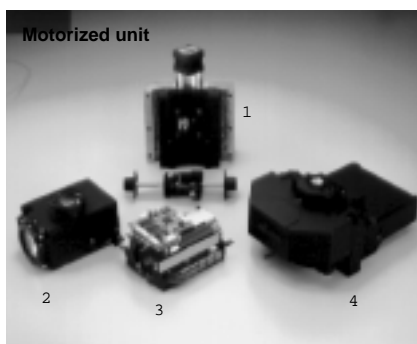

- 1 AX motorized focusing unit AX-FOM
- 2 AX motorized transmitted field stop unit AX-TFSM
- 3 AX motorized transmitted filter changer AX-TFCHM
- 4 AX motorized universal condenser AX-UCDM

The combination of motorized units with a multi-control box automates the entire microscopic procedure.

A motorized universal condenser allows quick, simplified changeover between

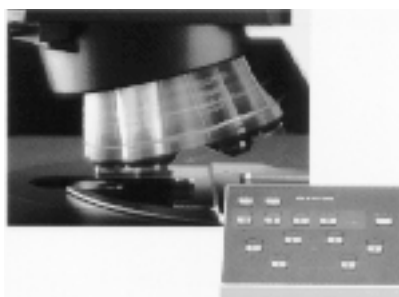

FISH and Fluorescence advantages

The PROVIS AX70 thoroughly addresses the concerns of Fluorescence and Fluorescence *In Situ* Hybridization (FISH) microscopy.

- UIS objectives produce fully corrected primary images. This leads to exceptional RGB image registration for high resolution CCDs.
- High N.A. fluorescence optimized Fluorite and Plan Apochromat objectives deliver images of exceptional brilliance, contrast and resolution.
- The wide choices of filter systems satisfies every fluorescent label and includes filter cubes for simultaneous multi wavelength excitation and emission. In addition, filter systems can be tailored to future demands.
- Ready adaptability of filter wheels to the massive stand enables the use of stationary multichroic beam-splitter emission filters with single, dual and triple wavelength exciter. This approach renders the highest registration accuracy.
- The chromatically corrected illumination beampath produces uniform fluorescence over a wide field of view, encompassing the entire excitation emission spectrum.
- Efficient heat and IR removal in the collector lens protects interference exciter filters from unnecessary energy.
- The automation capability (RS232C/GPIB) of the PROVIS AX70 makes it an ideal base for automated FISH imaging stations.



Sophisticated photo and video documentation systems.

U-PHOTO Universal Photo System

The U-PHOTO Universal Photo System is an automatic photomicrography system that provides fully automatic functions for photomicrography. These include a flexible spot measurement function, a Super FL Auto mode specifically designed for fluorescence photomicrography, and a zoom magnification changeover. The U-AFPHOTO system also features an auto focus mechanism capable of accommodating a wide range of microscopic techniques and objective magnifications. Each of these versatile functions can be controlled via the multi-control box for fully automatic photo documentation. The U-PHOTO 20/80 for simultaneous eyepiece and video camera observation is also available and is especially effective for use in pathology conferencing.

* For simultaneous observation, a video camera mounts onto the large-format port via the U-TVL.

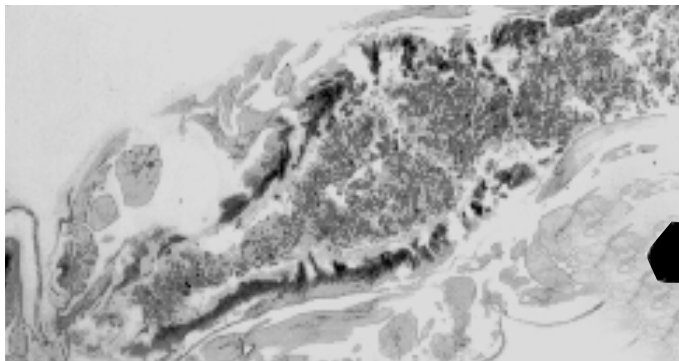

Distribution of copper accumulation in a larva of Ephemeroptera

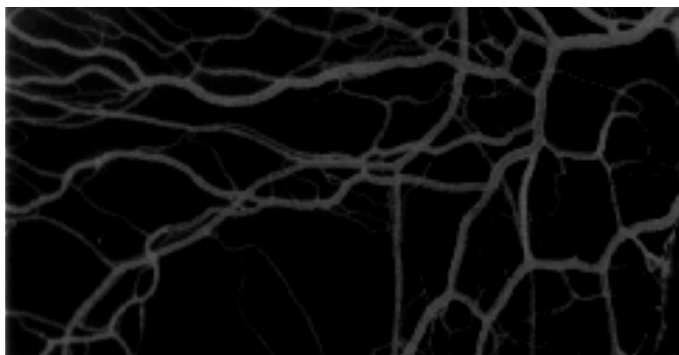

Microcirculation of the rat mesentery, fluorescein-dextran

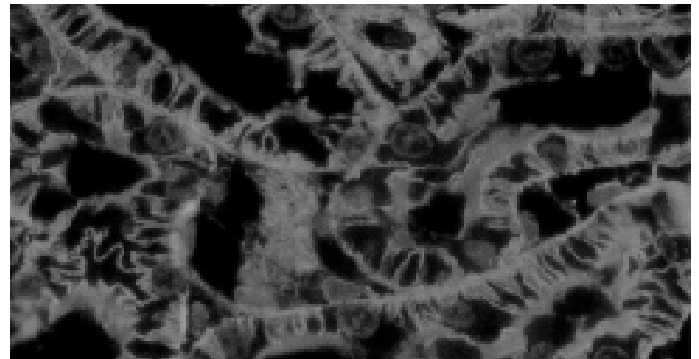

Rat kidney, triple-stain UBG

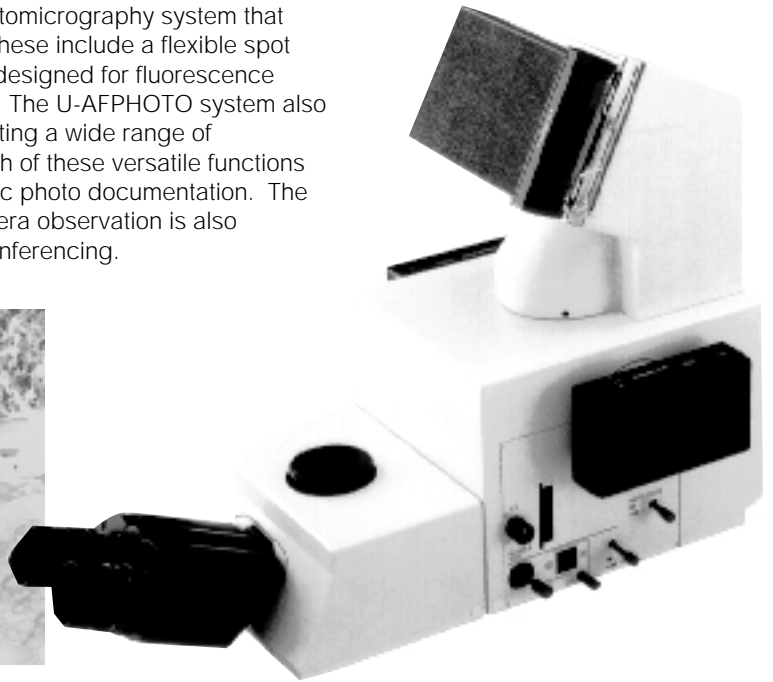

Flexible moving spot measurement.

The Universal Photo System features a flexible spot measurement function which allows the 0.1% micro-spot and 1% spot measurement areas to be moved without restriction to any desired location. This function is invaluable when a top-quality photomicrograph is required for instance of multi-stained fluorescent samples.

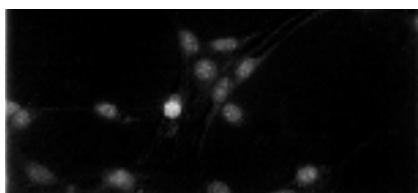

Super FL Auto mode for automatic exposure control.

The Super FL Auto mode is specifically designed for fluorescence photomicrography. It automatically selects and measures only the fluorescing image elements while automatically accounting for their field coverage. This mode enables operators of any experience level to take high-quality photomicrographs. This can be performed without making exposure corrections. Two other automatic exposure control modes are also available – the FL Auto and Auto modes, depending on sample conditions.

Zoom magnification change for versatile framing.

A 1x - 2x zoom magnification change system significantly eases zooming and trimming of a desired section to significantly increase framing options flexibility for video recording.

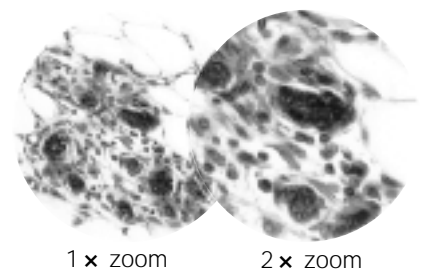

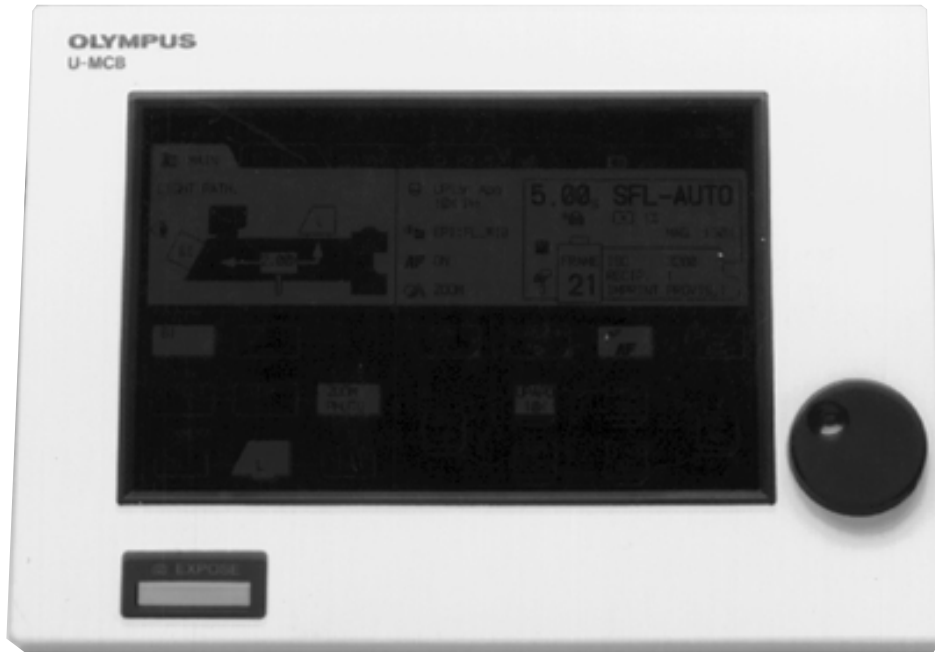

U-AFPHOTO offers auto focus capability for a wide range of microscope techniques.

The U-AFPHOTO is equipped with a high-performance auto focus mechanism that accommodates a wide range of objective magnifications (1.25 x -100 x), as well as brightfield, darkfield, fluorescence* and Nomarski DIC* observation methods. The focusing speed during ordinary brightfield observation has been raised significantly to achieve focus in only 0.3 - 2 seconds. In addition to the one-shot mode, a real-time mode is included to maintain specimen focus and significantly enhance observation efficiency even during objective and microscopic technique changeovers or specimen movement.

*The Auto focus function can be activated by inserting an optional memory card in fluorescence and Nomarski DIC observations.

3-way camera light path.

A built-in 3-way light path enables simplified photomicrography using monochromatic, color and large 2D format cameras without camera replacement.

Bright frame function for easy framing against a dark background.

The frame control function allows easy framing against a dark background during such observation methods as fluorescence and darkfield.

The brightness of the red- or yellow-colored frame can also be changed for smoother, faster frame adjustment.

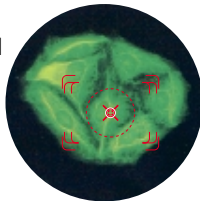

Fully automatic photomicrography via multi-control box.

The use of the multi-control box enables fully automatic photo and video documentation. Excellent visibility is also offered courtesy of a plasma display, while a touch panel keeps operation as simple as possible. The multi-control box represents maximum operational comfort – especially for frequent users of photomicrography or video documentation.

The U-MCB can be easily operated via the touch panel while setting the photomicrography conditions and various motorized units. The setup choices can be selected via the jog dial.



1. Photomicrography conditions setting screen

Selection of camera, framing, photomicrography mode and exposure mode can be made via this screen.



2. Illumination setting screen

Selection of on/off and changeover of light control, field diaphragm, AS and excitation light control can be made via this screen.



3. INIT(preferance) setting screen

Selection of motorized units such as objectives and mirror units can be made via this screen.



4. Auto focus setting screen

In addition to accommodating many microscopic techniques (except phase-contrast), the system's built-in real-time mode maintains constant specimen focus.

*Use of auto focus with AX70 requires U-AFPHOTO, AX-FOM, U-MCB and AX-PCBT. Since modification of AX70 unit is also required, please consult your Olympus dealer.

Fluorescence microscopy dedicated accessories support full research efficiency.

AX-REXBA*

The use of a dual-band filter allows simultaneous observation of double-stained specimens. With the conventional observation method, photomicrography or image documentation with optimally balanced light intensity is difficult since one of the two fluorochromes may emit fluorescence that is too weak or too strong. However, by simply turning the dial of the AX-REXBA, easy control of the fluorescence balance is assured for photomicrography with ideally balanced light.

* U.S. patent pending.

(1) Use of a dual-band filter, allows observation of and photomicrography with a double-stained fluorescing specimen under optimum conditions, regardless of the conditions of the stained specimen.

(2) As the AX-REXBA allows adjustment of excitation light, unnecessary irradiation is prevented and damage to the specimen is minimized.

(3) The 25EBFB/G filter accommodates a double-stained fluorescing specimen using two types of fluorochromes – FITC/TRITC and FITC/Texas Red. This filter is designed for general use with double-stained specimens with G/B excitation. The 25EBFU/B** filter designed for U/B excitation is also available.

** To be released October 1997.

(4) With single-band excitation, the AX-REXBA can serve as a continuous light control unit. (When 25EBFB/G is used, the AX-REXBA is applicable for B or G excitation).

(5) The AX-REXBA is easily installed into the AX70's aperture stop position.



Observation comparison without and with AX-REXBA.

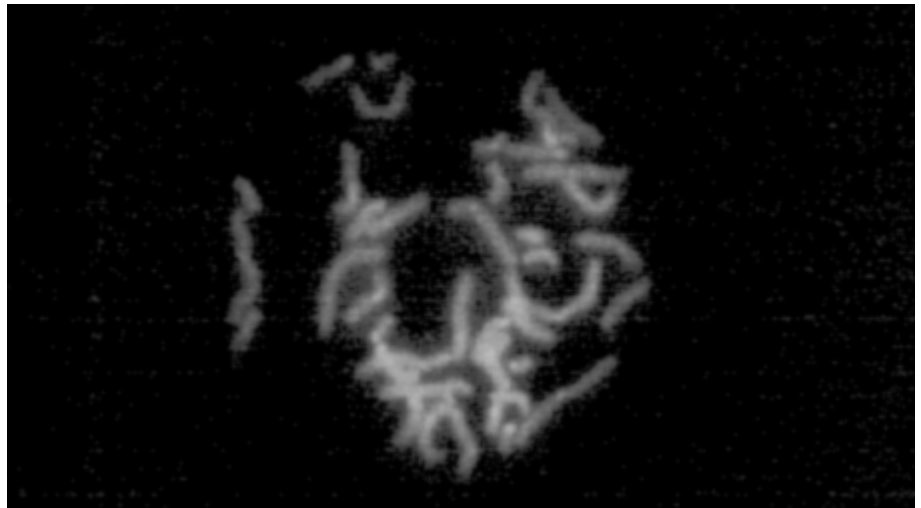

Human chromosome telomere/FITC + P₂, UPLAPO100x, PE3.3x

Without using AX-REXBA

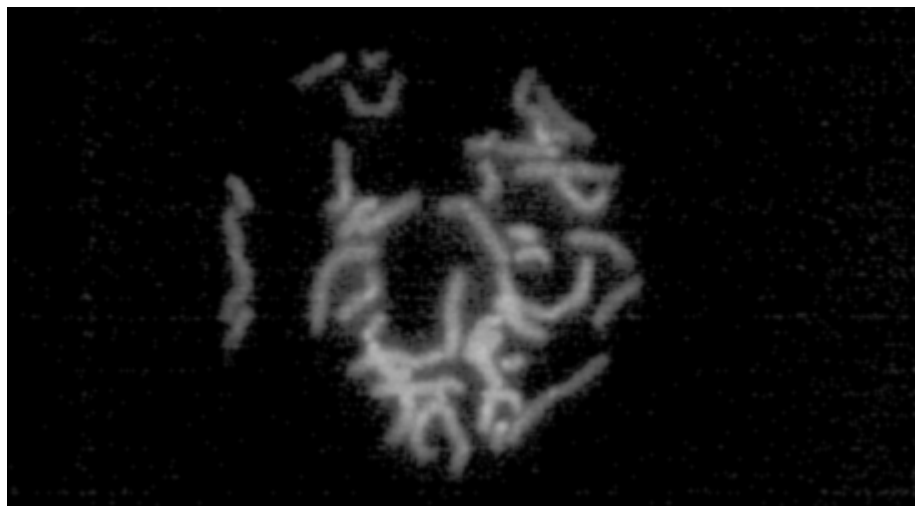

With use of AX-REXBA

Specimens viewed with AX-REXBA.

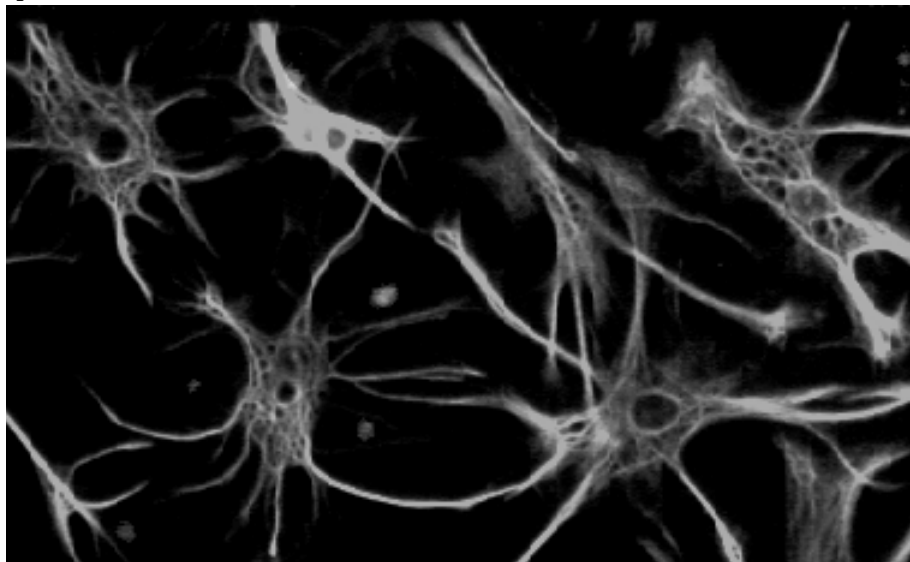

Rat originated cell culture
FITC/TRITC, UPLAPO40x, PE3.3x

TRITC enhanced

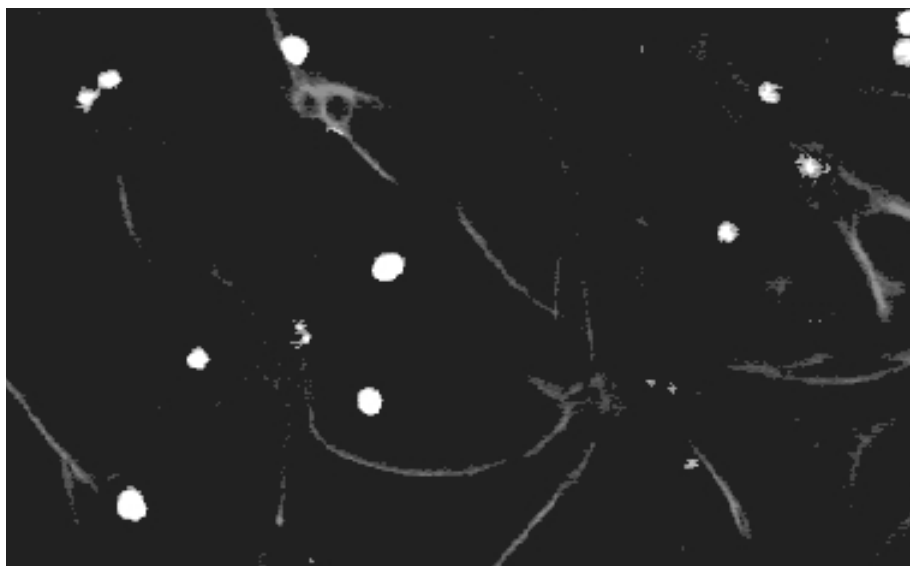

FITC enhanced

Precise correction for image deviation in multiple exposure.



Optical center adjuster AX-OCA

The AX-OCA effectively eliminates the deviations during multiple exposure.

Powerful partners provide solutions to specific application requirements.

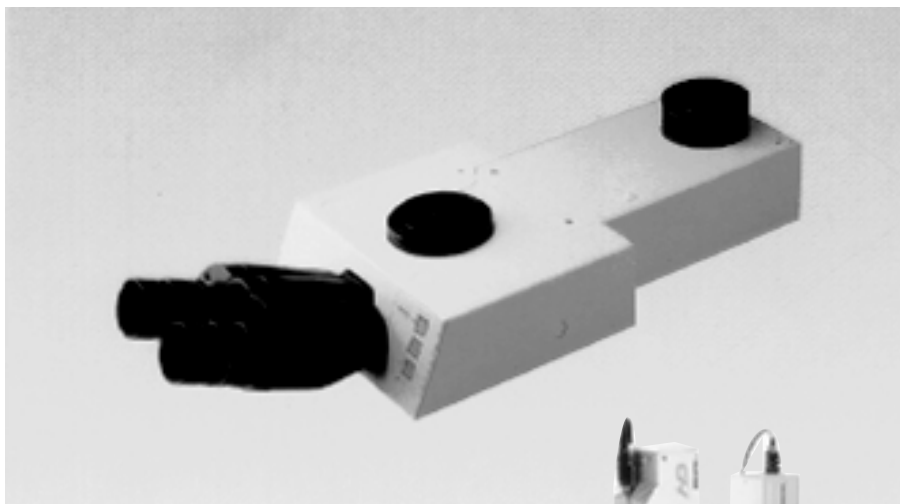

U-MPH multi-port head

The U-MPH enables erect image observation of a super widefield of view and makes simplified micromanipulation on the upright microscope possible. Centering, rotation, magnification and focus adjustments are also possible for the second image port. As a result, images from video cameras mounted on ports 1 and 2 offer perfect registration.

- Optional adapters allow multichannel measurement for up to five ports.
- Optical devices such as dichroic mirrors attached to ports 1 and 2 can be changed via the light path selector.



U-SWTR-2 super widefield trinocular tube



U-SWETR super widefield erect image trinocular tube

Observation tubes

The AX Series observation tubes range from "widefield binocular" to "super widefield erect image trinocular", corresponding to various observation needs.



PM30 automatic photomicrography system

The exclusive Super FL Auto mode provides fully automatic exposure control for effortless fluorescence photomicrography. The Auto mode accommodates all other observation methods and a host of other convenience features facilitate superior, trouble-free photomicrography.

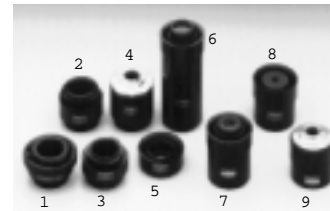

Video camera adapters

The AX trinocular tubes accept a variety of video camera adapters for various image systems such as image processing and video documentation systems.

- 1 U-IMAD 2 U-SMAD 3 U-BMAD
 4 U-CMAD 5 U-TV1X 6 U-TV0.5X
 7 U-PMTV 8 U-PMTV1X 9 U-PMTVC

AX70 specifications

Item	AX70	AX70+U-PHOTO/U-PHOTO20/80/U-AFPHOTO	
Microscope stand	Type	Y-shape frame with built-in transmitted/incident light vertical illuminator	
	Optical system	UIS optical system (infinity-corrected/compensation-free)	
	Transmitted illumination	12V100W halogen (2,000 hours long-life type), pre centered Mechanical field diaphragm (motorized field diaphragm unit attachable) Six built-in manual filters (ND1.5, ND3, ND6, ND12, IF550, LBD; motorized filter changer attachable) One optional external filter can be user-installed (manual operation)	
	Incident illumination	Universal vertical illuminator, 12V100W halogen/Hg100W/Xe75W applicable, optical devices detachable, motorized mirror unit changer, excitation light shutter (interlocking operation when changing an objective/observation method). Max. three filter sliders (six filters) attachable (when using AX-RFCH)	
	Illumination adjustment	1-12V (adjustable in units of 0.1V by the jog dial), light preset switch, transmitted/incident halogen illumination changeover switch	
	Focus	Vertical stage movement by manual roller guide, stage travel range: 25mm. Coaxial coarse and fine focus handle, minimum fine focus adjustment graduation: 1µm increments, stroke per rotation: 0.1mm (fine), 15mm (coarse). Sensitivity: less than 1µm	
	Operation control position	Main switch located at power supply (U-PS), light adjustment dial: right front, field control knob: left front, sub-main switch, changeover switch for transmitted/incident illumination, light preset switch: right wing of frame, hand switch attached (objectives direct changeover, objectives recall, mirror unit direct changeover. Incident excitation shutter on/off, lamp off possible)	
	Power supply (U-PS)	100/120/220/230/240 V automatic changeover, main switch attached	
Observation tube	(when using U-SWTR-2) F.N. 26.5 (super widefield), adjustable interpupillary distance range: 50-76mm, inclined 24°, right eyepiece sleeve correction mechanism, photo focusing can be attached, reticle/photo mask rotation stop included, (erect image, U-SWETR attachable)	Integrated in photomicrographic unit	
Revolving nosepiece	Motorized sextuple nosepiece, motorized quintuple nosepiece for reflected darkfield observation, various manual nosepieces attachable		
Stage	Stroke range: 52 x 76mm (with vernier), max two sliders can be inserted, torque adjustable, selectable from right handle or left handle, knob position (tip): 57mm from desk top		
Condenser holder	Vertical stroke range: 25mm (when using AX-UCDM: 10mm), centering adjustment function (AX-UCDM: standard feature), both sides condenser movement control knobs, (AX-UCDM: motorized)		
Photomicrography unit	Observation tube	—	F.N. 26.5 (super widefield), adjustable interpupillary distance range: 50-76mm, inclined 24°, magnification [(direct optical path: 1 x, optical path through zoom: 1-2 x (zoom)]
	Camera	—	Two 35mm cameras, one large-format camera, one video camera (all can be attached at the same time); two video cameras can be mounted by connecting U-TVL to the large-format port; selectable by U-MCB
	Optical path changeover	—	<ul style="list-style-type: none"> ●U-PHOTO/U-AFPHOTO [Direct optical path] BI : video camera (direct) = 100:0/0:100 [Peripheral optical path] (all light goes to camera optical path during exposure) BI : video camera (direct) : video camera 2 : photometry = 100:0:0/0 : 0:100:0/0 : 0:0:100:0 / 20:0:0:80 / 0:20:0:80 (video camera 2 is mounted to the large-format port via U-TVL.) When using auto focus function of U-AFPHOTO: BI : video camera (direct) : video camera 2 : photometry : AF sensor = 50:0:0:0:50 / 0:50:0:0:50 / 0:0:50:0:50 / 10:0:0:80:10 / 0:10:0:80:10 [Camera optical path] 35mm left : large-format : 35mm right = 100:0:0 / 0:100:0 / 0:0:10:0 When using video camera 2 35mm left : 35mm right = 100:0 / 0:100 ●U-PHOTO20/80 [Direct optical path] BI : video camera (direct) = 100:0 / 0:100 [Peripheral optical path] (80% of all light goes to camera optical path during exposure) BI : video camera (direct): video camera 2 : photometry = 20:0:80:0 / 100:0:0:0 / 0:100:0:0 / 20:0:0:80 / 0:20:0:80 (video camera 2 is mounted to large-format port via U-TVL) [Camera optical path] 35mm left : large-format : 35mm right = 100:0:0 / 0:100:0 / 0:0:100 When using video camera 2 35mm left : 35mm right = 100:0 / 0:100
	Photo magnification	—	35mm camera: 2.5x-5x, large-format camera: 7.5x-15x
	Zoom	—	Motorized control by jog dial or fixed magnification switch of U-MCB. Zoom ratio: 2 x
	Focusing telescope	—	Manual insertion, magnification ratio: 3.4 x (besides U-AFPHOTO)
	Photo frame reticle	—	Manual insertion, bright frame operation (red/yellow), illumination adjustment (seven levels)
	Shutter	—	Pulse-control electromagnetic shutter, shutter speed: max. 1/125 sec.
	Photometry	—	2D image analysis memory mode by the CCD. 0.1% spot measurement, 1% spot measurement, 30% average measurement switchable. Flexible spot measurement area, spot color switchable (red/yellow)
	Photometry conditions	—	Five exposure modes: Auto mode, FL Auto mode, Super FL Auto mode, Manual mode, time mode. Auto exposure range: 1/125 sec.-68min. ISO: 3-25,600 (automatic setting by DX method, manual setting also possible). 13-step exposure control (0.25-4, every 1/3 step). Auto bracketing function, eight-level reciprocity failure correction, multi-exposure, AE lock, exposure time recall, data/scale imprinting function (by imprinting unit)
	Camera back	—	35mm (PM-C35DX): auto loading/wind/rewind and automatic film detection, data imprinting unit can be attached, automatic setting of the ISO value by the DX code. Frame counting number is retained for data back-up. Data imprinting unit (PM-DI-35); backlit exchange type Large-format camera back (attached to U-DLF); Polaroid (PM-CP-3)
Multi-control box (U-MCB)	—	Operation by transmitted touch panel and jog dial sheet switch. Graphics indicated on plasma display. Centralized control of mentioned photomicrography conditions and all motorized parts are possible. Memory card function: can register, recall, delete, print the information of photometry and observation. External interface function: selectable from RS232C, GPIB or printer interface (optional)	
Auto focus (on U-AFPHOTO only)	—	Optical path difference based contrast system. Operation modes: real-time mode and one-shot mode (switchable). Applicable magnifications: 1.25 x -100 x. Applicable condensers: AX-UCDM, U-UCDB, U-AAC, U-ULC-2. Applicable microscopic observation: brightfield/darkfield, Nomarski DIC, polarized light (both transmitted and incident light), fluorescence (incident light only)	
Eyepiece	10x, F.N. 26.5 (super widefield of view)		
Objectives	Conform to ISO (*1) PLAPO set: PLAPO2 x UPLAPO set: PLAPO2 x UPLAFL set: PLAPO2 x UPLAPO4 x UPLAPO4 x UPLAFL4 x UPLAPO10 x UPLAPO10 x UPLAFL10 x UPLAPO20 x UPLAPO20 x UPLAFL20 x PLAPO40 x UPLAPO40 x UPLAFL40 x PLAPO100 x O UPLAPO100 x O UPLAFL100 x O		
Condensers	Universal motorized condenser for AX (AX-UCDM): N.A. 0.16-0.9 (N.A. 0.16-1.4 with change of top lenses), objectives (1.25 x -100 x). Turret, aperture diaphragm, top lens changeover polarizing plate attachment insertion: all motorized. Applicable for transmitted brightfield, transmitted darkfield, transmitted phase-contrast, transmitted Nomarski DIC, transmitted simple polarizing observations. Swing-out Achromat (U-SC): N.A. 0.16-0.9, objectives (2 x -100 x). Achromat/Aplanat (U-AAC): N.A. 1.4, objectives (10 x -100 x). Universal (U-UCDB): N.A. 0.2-0.9, objectives (2 x -100 x). Phase-contrast darkfield (U-PCD): N.A. 1.25, objectives (10 x -100 x). For super low magnification (U-ULC-2): N.A. 0.16, objectives (1.25 x -4 x). Darkfield (dry): N.A. 0.8-0.92, objectives (10 x -40 x). Darkfield (oil): N.A. 1.20-1.40, objectives (10 x -100 x)		

(*1) Conform to ISO9345-1, ISO8038.

AX70 dimensions (unit: mm)

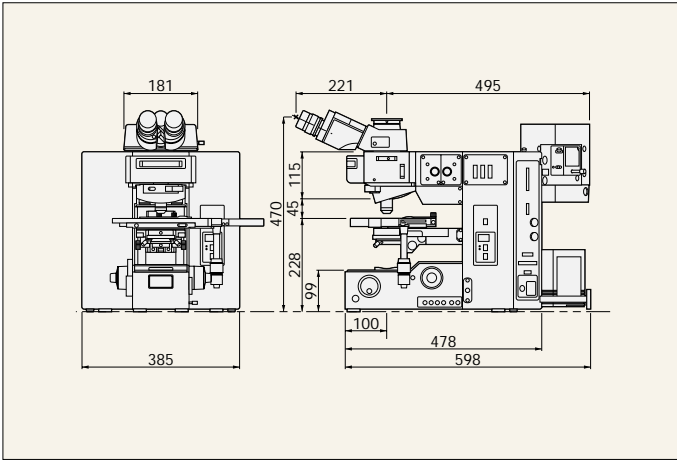

AX70 + Universal Photo System dimensions (unit: mm)

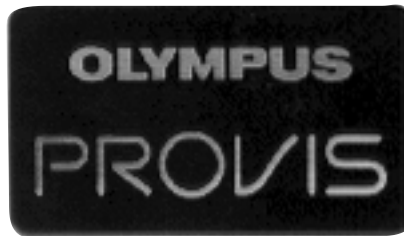
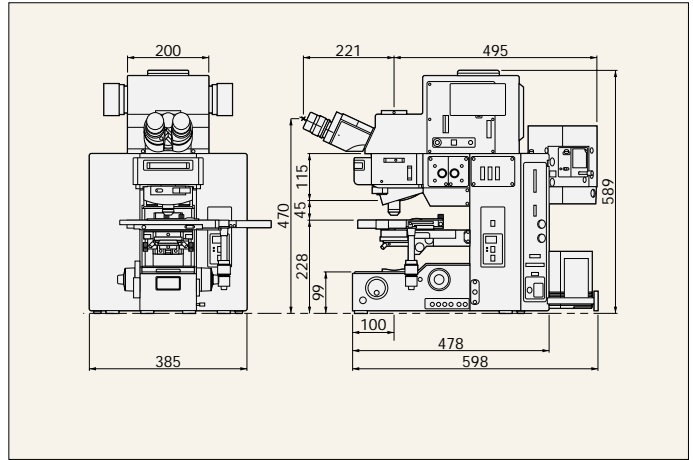

Specifications are subject to change without any obligation on the part of the manufacturer.



OLYMPUS

OLYMPUS OPTICAL CO. LTD.
 San-Ei building, 22-2, Nishi Shinjuku 1-chome, Shinjuku-ku, Tokyo, Japan
OLYMPUS OPTICAL CO. (EUROPA) GMBH.
 Postfach 10 49 08, 20034, Hamburg, Germany
OLYMPUS AMERICA INC.
 2 Corporate Center Drive, Melville, NY 11747-3157, U.S.A.
OLYMPUS SINGAPORE PTE LTD.
 491B River Valley Road, #12-01/04 Valley Point Office Tower, Singapore 248373

OLYMPUS OPTICAL CO. (UK) LTD.
 2-8 Honduras Street, London EC1Y 0TX, United Kingdom.
OLYMPUS AUSTRALIA PTY. LTD.
 31 Gilbey Road, Mt. Waverley, VIC 3149, Melbourne, Australia.
OLYMPUS LATIN AMERICA, INC.
 6100 Blue Lagoon Drive, Suite 390 Miami, FL 33126-2087, U.S.A.

www.olympus.com